



# Guide on tips, SmarTips and adapters EXFO's inspection scopes (FIP-500 and FIP-400)

The largest range of tip adapters in the industry to match any connector, in all settings possible.

PATCHCORD TIPS / BULKHEAD ADAPTERS / APC AND UPC /  
SINGLE FIBER / MULTIFIBER / DUPLEX



Smarter  
network  
in sight.

 **Specialized Products**  
C O M P A N Y

**EXFO**

# FIP-500 SmartTips

Fastest inspection in the industry for duplex, single-fiber, and multi-fiber connectors



**Did you know?**  
By tapping your SmartTip on the FIP-500, pass/fail thresholds will be automatically adjusted to the type of connector under test.  
This remarkable level of automation prevents threshold selection mistakes and makes fiber inspection easier than ever!



## Innovative and patented Quick-connect mechanism

Swap tips in a quarter-turn click—a small but life-changing innovation. No loose parts, not a second wasted. Tip switching can be done with one hand, if needed.

It has never been easier to swap between single fiber, duplex and multi fiber tips.





# SmarTips for most common connectors types

Each connector needs the appropriate adapter when it comes to fiber inspection. To make it as easy as possible to use or order the tip adapter needed, EXFO has put together this quick reference guide. It includes the full array of tips available, associated connectors and respective ordering information.









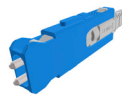
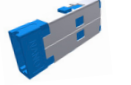

## FIP-500 SmarTips for single-fiber connectors

Optical head	Adapter tips APC		Connector	Adapter tips UPC		Optical head			
	Male	Female		Male	Female				
 <p>OHSF Optical head for single-fiber</p>  <p>OHSF-A60 Optical head with 60° angle for single-fiber</p>	 <p>STIP-U2.5-A</p>	 <p>STIP-SC-A</p>	 <p>SC Simplex</p>		 <p><u>STIP-SC-FC-U</u></p>	 <p>OHSF Optical head for single-fiber</p>  <p>OHSF-A60 Optical head with 60° angle for single-fiber</p>			
		 <p>STIP-SC-A-L (long reach, for areas that are difficult to access)</p>	 <p>SC Duplex</p>		 <p>STIP-SC-U-L (long reach, for areas that are difficult to access)</p>				
		 <p>STIP-FC-A</p>	 <p>FC Simplex</p>		 <p><u>STIP-SC-FC-U</u></p>				
		N/A	 <p>ST Simplex</p>		 <p><u>STIP-ST-U</u></p>				
		 <p>STIP-E2000-A</p>	 <p>E2000 Simplex</p>		 <p>STIP-E2000-U</p>				
		 <p>E2000 Duplex</p>							
		 <p>STIP-U1.25-A</p>	N/A	 <p>MU Simplex</p>			 <p>STIP-U1.25-U</p>	 <p><u>STIP-LC-U</u></p>	
			 <p>STIP-LC-A</p>	 <p>MU Duplex</p>					 <p>STIP-LC-U-L</p>
			 <p>STIP-LC-A-L</p>	 <p>LC Simplex</p>					 <p>STIP-LC-U-A60</p>
			 <p>STIP-LC-A-A60</p>	 <p>LC Duplex</p>					 <p><u>STIP-LC-DF-U</u></p>
			 <p>LC Duplex bulkhead adapter</p>	 <p><u>STIP-LC-DF-U</u></p>	 <p>OHMF Optical head for multi-fiber</p>  <p>OHMF-A60 Optical head with 60° angle for multi-fiber</p>				



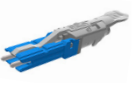







































## FIP-500 SmarTips for multi-fiber connectors

Optical head	Tip	Jumper	Connector	Bulkhead	Tip	Optical head
	 <p>RAC-MPO-12-Type A (key up/key down) + STIP-MPO-U</p>		MPO-8/12/24/48 UPC		 <p>STIP-MPO-U</p>	
	 <p>RAC-MPO-12-Type A (key up/key down) + STIP-MPO-A</p>		MPO-8/12/24/48 APC		 <p>STIP-MPO-A</p>	
	 <p>RAC-MPO-16-Type A + STIP-MPO-U</p>		MPO 16/32/64 UPC		 <p>STIP-MPO-U</p>	
 <p>OHMF Optical head for multi-fiber</p>	 <p>RAC-MPO-16-Type A + STIP-MPO-A</p>		MPO 16/32/64 APC		 <p>STIP-MPO-A</p>	 <p>OHMF Optical head for multi-fiber</p>
 <p>OHMF-A60 Optical head with 60° angle for multi-fiber</p>	 <p>RAC-MPO-12-Type A (key up/key down) + STIP-MPO-A-KL</p>		CommScope SYSTIMAX		 <p>STIP-MPO-A-KL</p>	 <p>OHMF-A60 Optical head with 60° angle for multi-fiber</p>
	 <p>RAC-MPO-12-MT + STIP-MPO-U</p>		MPO-MT Ferrule UPC	 <p>RAC-MPO-12-MT</p>	 <p>STIP-MPO-U</p>	
	 <p>RAC-MPO-12-MT + STIP-MPO-A</p>		MPO-MT Ferrule APC	 <p>RAC-MPO-12-MT</p>	 <p>STIP-MPO-A</p>	

## FIP-500 SmarTips for duplex connectors

Optical head	Tip	Jumper	Connector	Bulkhead	Tip	Optical head
 OHMF Optical head for multi-fiber	 STIP-SN-DF-U		SN Duplex	 SN bulkhead adapter	 STIP-SN-DF-U	 OHMF Optical head for multi-fiber
 OHMF-A60 Optical head with 60° angle for multi-fiber	 STIP-CS-DF-U		CS Duplex	 CS bulkhead adapter	 STIP-CS-DF-U	 OHMF-A60 Optical head with 60° angle for multi-fiber

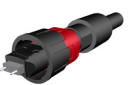
## FIP-500 SmarTips for FTTX connectors

Optical head	Tip	Socket	Connector	Plug	Tip	Optical head
 OHSF Optical head for single-fiber	 STIP-U2.5-A		OptiTap® (OptiSheath® Multiport terminal, in-line tether extender or flexible service terminals)		 STIP-OTAP-A	 OHSF Optical head for single-fiber
 OHSF-A60 Optical head with 60° angle for single-fiber	 STIP-SFADP-400		Outdoor connector (ODC) 2 fibers		 STIP-SFADP-400 +  FIPT-400-ODC- 2PIN-P-K	 OHSF-A60 Optical head with 60° angle for single-fiber
	 FIPT-400-ODC-S		Outdoor connector (ODC) 4 fibers		 STIP-SFADP-400 +  FIPT-400-ODC- 4PIN-P-K	
 OHMF Optical head for multi-fiber	 STIP-QODC-12-U-F		Outdoor connector Q-ODC-12 UPC		 STIP-QODC-12-U-M	 OHMF Optical head for multi-fiber
	 STIP-QODC-12-A-F		Outdoor connector Q-ODC-12 APC		 STIP-QODC-12-A-M	
 OHMF-A60 Optical head with 60° angle for multi-fiber	 STIP-QODC-2-DF-U-F note: the duplex tip tests 2 connectors simultaneously		Q-ODC Duplex		 STIP-QODC-2-DF-U-M note: the duplex tip tests 2 connectors simultaneously	 OHMF-A60 Optical head with 60° angle for multi-fiber
	 STIP-OTIP-A-F		OptiTip® and HMFOC® Up to 12 fibers		 STIP-OTIP-A-M	 OHMF-A60 Optical head with 60° angle for multi-fiber
	 STIP-IP9-MPO-A		IP9-MPO		 STIP-MPO-A	





# FIP-500 SmarTip ordering information

EXFO offers multiple patchcord tips and bulkhead adapters for both single-fiber and multi-fiber applications. These tips and adapters are built to fit the wide range of fiber connector types and design encountered in the field. The following tips and adapters are compatible with EXFO's FIP-500 and FIP-400 series and can be ordered separately or in kits. Please refer to the chart below for complete ordering information.

## Optical head

Part number	OHSF	OHSF-A60	OHMF	OHMF-A60
Description	Optical head for single-fiber	Optical head with 60° angle for single-fiber	Optical head for multi-fiber	Optical head with 60° angle for multi-fiber
				







## STIPs adapters

Part number	STIP-SFADP-400	RAC-MPO-12-MT	RAC-MPO-12-TypeA	RAC-MPO-16-TypeA
Description	FIP-500 adapter to support FIPT-400 single-fiber tips	MPO-12 to MT hybrid bulkhead connector (for MT ferrule inspection with a FIP-500 equipped with OHMF optical head and STIP-MPO compatible) APC and UPC	MPO-12 bulkhead connector Type A (APC): opposite key (key up to key down)	MPO-16 bulkhead connector Type A (APC): opposite key (key up to key down)
				



## Universal patchcord STIPs

Part number	STIP-U1.25-U	STIP-U1.25-A	STIP-U2.5-U	STIP-U2.5-A
Description	Universal 1.25 mm/UPC patchcord	Universal 1.25 mm/APC patchcord	Universal 2.5 mm/UPC patchcord	Universal 2.5 mm/APC patchcord
				



## Bulkhead STIPs FC/SC

Part number	STIP-SC-FC-U	STIP-FC-A	STIP-SC-A	STIP-SC-U-L	STIP-SC-A-L
Description	SC/UPC and FC/UPC bulkhead connector	FC/APC bulkhead connector	SC/APC bulkhead connector	SC/UPC extended bulkhead connector	SC/APC extended bulkhead connector
					
Part number	STIP-SC-U-A60	STIP-OTAP-A			
Description	LC/UPC, 60° angle bulkhead connector	OptiTap/APC bulkhead connector			
					





## Bulkhead STIPs LC

Part number	<u>STIP-LC-U</u>	<u>STIP-LC-A</u>	<u>STIP-LC-U-A60</u>	<u>STIP-LC-A-A60</u>	<u>STIP-LC-U-L</u>	<u>STIP-LC-A-L</u>
Description	LC/UPC bulkhead connector	LC/APC bulkhead connector	LC/UPC, 60° angle bulkhead connector	LC/APC, 60° angle bulkhead connector	LC/UPC extended bulkhead connector	LC/APC extended bulkhead connector
						

## Specials STIPs

Part number	<u>STIP-E2000-U</u>	<u>STIP-E2000-A</u>	<u>STIP-MU-U</u>	<u>STIP-ST-U</u>
Description	E-2000/UPC bulkhead connector	E-2000/APC bulkhead connector	MU/UPC extended bulkhead connector	ST/UPC bulkhead connector
				

## Duplex STIPs

Part number	<u>STIP-LC-DF-U</u>	<u>STIP-CS-DF-U</u>	<u>STIP-SN-DF-U</u>	<u>STIP-QODC-2-DF-U</u>
Description	LC/UPC DUPLEX bulkhead connector	CS/UPC DUPLEX bulkhead connector	SN/UPC DUPLEX bulkhead connector	UPC DUPLEX bulkhead connector Male/female included
				

## Multi-fiber STIPs

Part number	<u>STIP-MPO-U</u>	<u>STIP-MPO-A</u>	<u>STIP-IP9-MPO-A</u>	<u>STIP-MPO-A-KL</u>	<u>STIP-QODC-12-U</u>	<u>STIP-QODC-12-A</u>
Description	MPO/UPC for MPO 8/12/16 up to 4 rows	MPO/APC for MPO 8/12/16 up to 4 rows	IP9 MPO/APC connectors	Keyless MPO/APC for MPO 8/12/16 up to 4 rows. Compatible with CommScope inverted key system	UPC (12 fibers) Male/female included	APC (12 fibers) Male/female included
						
Part number	<u>STIP-OTIP-A</u>					
Description	OptiTip™-HMFOC®/ APC Male/female included					
						

## Kit STIPs

Part number	STIP-SCU-K	STIP-SCA-K	STIP-LC-K	STIP-LCU-K	STIP-LCA-K
Description	Universal 2.5 mm/ SC-UPC kit includes: › STIP-U2.5-U › STIP-SC-FC-U	Universal 2.5 mm/ SC-APC kit includes: › STIP-U2.5-A › STIP-SC-A	LC kit includes: › STIP-LC-U: FIP-500 SmarTip: LC/UPC bulkhead connector › STIP-LC-A: FIP-500 SmarTip: LC/APC bulkhead connector › STIP-U1.25-U: FIP-500 SmarTip: Universal 1.25 mm/UPC patchcord › STIP-U1.25-A: FIP-500 SmarTip: Universal 1.25 mm/APC patchcord	LC/UPC kit includes: › STIP-LC-U: FIP-500 SmarTip: LC/UPC bulkhead connector › STIP-U1.25-U: FIP-500 SmarTip: Universal 1.25 mm/UPC patchcord	LC/APC kit includes: › STIP-LC-A: FIP-500 SmarTip: LC/APC bulkhead connector › STIP-U1.25-A: FIP-500 SmarTip: Universal 1.25 mm/APC patchcord
					

## Accessories

Part number	GP-2299	GP-2302	GP-10-071	GP-10-116
Description	Compartmented plastic case for STIP	Belt holster for FIP-500	Small-size soft carrying case	Rigid carrying case
				



# FIP-500 compatibility with FIPT-400 tips

FIP-500

OPTICAL HEAD

ADAPTER

FIPT-400 TIP

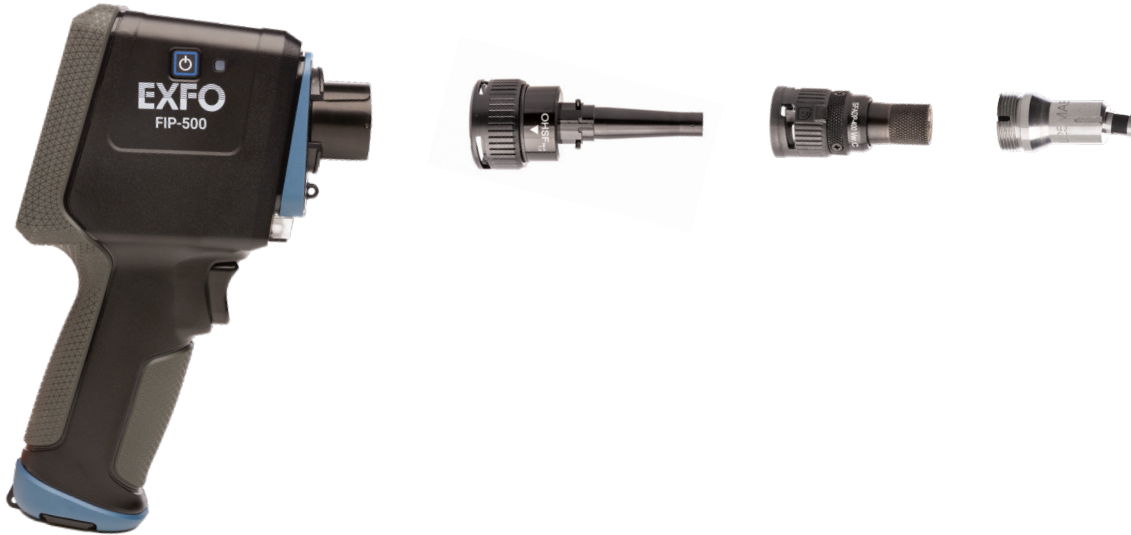

FIPT	COMPATIBILITY WITH STIP-SFADP-400	FIP-500 EQUIVALENT AVAILABILITY
FIPT-400-AD-A6	X	✓ OHSF-A60 ✓ OHMF-A60
FIPT-400-CS	✓ rev. C	✓ STIP-CS-DF-U
FIPT-400-D4	✓ rev. A and C	X
FIPT-400-E2000-APC	X	✓ STIP-E2000-A
FIPT-400-E2000-UPC	X	✓ STIP-E2000-U
FIPT-400-FC/APC	✓ rev. A and C	✓ STIP-FC-A
FIPT-400-FC-SC	✓ rev. C	✓ STIP-SC-FC-U
FIPT-400-FC-SC-A6	X	✓ STIP-SC-U-A60
FIPT-400-LC-A6	X	✓ STIP-LC-U-A60
FIPT-400-LC-APC	✓ rev. C	✓ STIP-LC-A
FIPT-400-LC-APC-L	✓ rev. C	✓ STIP-LC-A-L
FIPT-400-LC-L (UPC)	✓ rev. C	✓ STIP-LC-U-L
FIPT-400-LC-L-137	✓ rev. A and C	✓ STIP-LC-U-L
FIPT-400-LC-SQ	✓ rev. C	✓ STIP-LC-U
FIPT-400-MDC	✓ rev. A and C	X
FIPT-400-MIL-2CPA	✓ rev. C - X	X
FIPT-400-MU	✓ rev. A and C	✓ STIP-MU-U
FIPT-400-MU-L	✓ rev. A and C	X
FIPT-400-MU-L-149	✓ rev. A and C	X
FIPT-400-ODC-2PINP	✓ rev. A and C	✓ STIP-QODC-2-DF-U-M
FIPT-400ODC2PINP-K	✓ rev. C	X
FIPT-400-OTAP-APC	X	✓ STIP-OTAP-A

FIPT	COMPATIBILITY WITH STIP-SFADP-400	FIP-500 EQUIVALENT AVAILABILITY
FIPT-400-SC-APC	✓ rev. A and C	✓ STIP-SC-A
FIPT-400-SC-APC-L	✓ rev. C	✓ STIP-SC-A-L
FIPT-400-SC-L	✓ rev. C	✓ STIP-SC-U-L
FIPT-400-SC-L-149	✓ rev. A and C	✓ STIP-SC-U-L
FIPT-400-SN	✓ rev. C	✓ STIP-SN-DF-U
FIPT-400-ST/UPC	✓ rev. A and C	✓ STIP-ST-U
<u>FIPT-400-U12M</u>	✓ rev. C	✓ STIP-U1.25-U
<u>FIPT-400-U12MA</u>	✓ rev. C	✓ STIP-U1.25-A
FIPT-400-U16F	✓ rev. A and C	X
<u>FIPT-400-U16M</u>	✓ rev. A and C	X
<u>FIPT-400-U20M2</u>	✓ rev. A and C	X
<u>FIPT-400-U20M2</u>	✓ rev. C	X
<u>FIPT-400-U25M</u>	✓ rev. C	✓ STIP-U2.5-U
<u>FIPT-400-U25MA</u>	✓ rev. C	✓ STIP-U2.5-A
FIPT-400-U25MA-R	✓ rev. C	X
FIPT-400-U25M-R	✓ rev. C	X

FIPT	COMPATIBILITY WITH STIP-SFADP-400	FIP-500 EQUIVALENT IN DEVELOPMENT
<u>FIPT-400-LC-D (APC &amp; UPC)</u>	✓ rev. A and C	STIP-LC-DF-A
FIPT-400-MDC-APC	✓ rev. C	STIP-MDC-DF-A
FIPT-400-ODC-S	✓ rev. A and C	STIP-ODC-4-DF

# FIP-400 Tip series

Our FIP-400B fiber inspection scopes use a different set of tips. However, these tips can also be used with the FIP-500 by simply adding the optical head for single fiber.

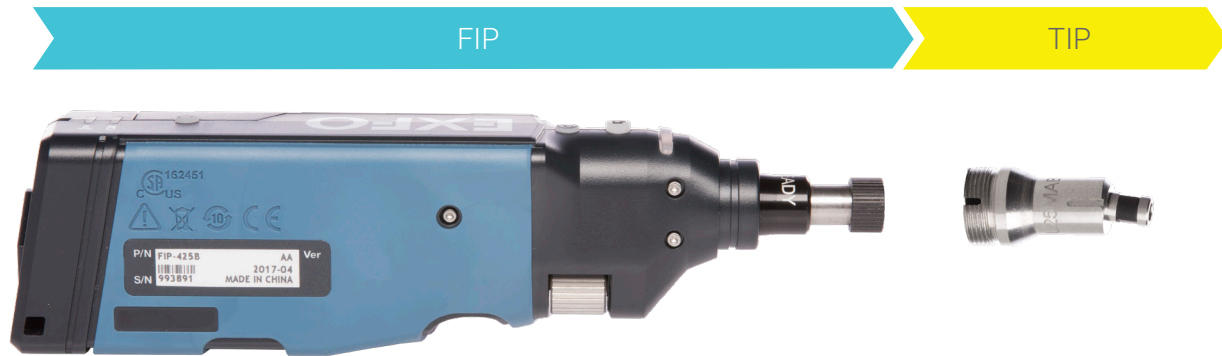

Listed below are the most common types of connectors and tips for the FIP-400B series or the FIP-500 equipped with an OHSF.













## Single-fiber connectors

Adapter tips APC		Connector	Adapter tips UPC			
Male	Female		Male	Female		
 FIPT-400-U25MA	 <a href="#">FIPT-400-SC-APC</a>	 SC Simplex	 FIPT-400-U25M	 <a href="#">FIPT-400-FC-SC</a>		
	 <a href="#">FIPT-400-FC-APC</a>	 SC Duplex	 FIPT-400-U25M			
	N/A	 FC Simplex	 FIPT-400-U25M		 <a href="#">FIPT-400-ST</a>	
	 FIPT-400-E2000-APC	 ST Simplex	 FIPT-400-U25M		 FIPT-400-E2000	
	 FIPT-400-E2000-APC	 E2000 Simplex	 FIPT-400-U25M		 FIPT-400-E2000	
 FIPT-400-U12MA	 FIPT-400-LX5-APC	 LX-5 Simplex	 FIPT-400-U12M	 FIPT-400-LX.5		
	N/A	 LX-5 Duplex			 FIPT-400-U12M	
	N/A	 MU Simplex			 FIPT-400-U12M	 FIPT-400-MU
	N/A	 MU Duplex			 FIPT-400-U12M	 FIPT-400-MU
 FIPT-400-LC-D-APC	 FIPT-400-LC-APC	 LC Simplex	 FIPT-400-LC-D	 <a href="#">FIPT-400-LC-SQ</a>		
	N/A	 LC Duplex			 FIPT-400-LC-D	











Not needed when dedicated nozzle for male connector is available, see next page.

### MF-Ready FIP-400B series FIPT for MPO connectors

Jumper	Connector			Bulkhead
FIPT-400-MF-MPO * 		MPO 12-24 UPC		FIPT-400-MF-MPO * 
FIPT-400-MF-MPO-APC * 		MPO 12-24 APC		FIPT-400-MF-MPO-APC * 
FIPT-400-MF-MPO-X * 		MPO 16-32 UPC		FIPT-400-MF-MPO-X * 

### MF-Ready FIP-400B series FIPT for FTTH connectors

Drop cable	Connector			Terminal port
FIPT-400-U25MA 		OptiTap® (OptiSheath® multiport terminal, in-line tether extender or flexible service terminals)		FIPT-400-OTAP-APC 
FIPT-400-MF-OTIP-MT-APC * 		OptiTip® and HMFOC® Up to 12 fibers		FIPT-400-MF-OTIP-MT-APC * 





### MF-Ready FIP-400B series FIPT for FTTA connectors

Socket	Connector			Plug
FIPT-400-ODC-S 		Outdoor connector (ODC) 2 fibers		FIPT-400-ODC-2PIN-P-K 
		Outdoor connector (ODC) 4 fibers		FIPT-400-ODC-4PIN-P-K 
FIPT-400-MF-QODC-12 * 		Outdoor connector Q-ODC-12 UPC		FIPT-400-MF-QODC-12 * 
FIPT-400-MF-QODC-12-APC * 		Outdoor connector Q-ODC-12 APC		FIPT-400-MF-QODC-12-APC * 



\* Requires the FIP-400B MF-Ready version

# FIP-400 Tip ordering information





## Universal patchcord FIPT-400 tips

Part number	<b>FIPT-400-U12M</b>	<b>FIPT-400-U12MA</b>	<b>FIPT-400-U16M*</b>	<b>FIPT-400-U16F</b>	<b>FIPT-400-U20M2</b>	<b>FIPT-400-U25M</b>
Description	Universal patchcord tip for 1.25 mm ferrules	Universal patchcord tip for 1.25 mm ferrules (APC)	Universal 1.6 mm/PC tip for male connector	Universal 1.6mm/PC bulkhead (female side)	Universal patchcord tip for 2.0 mm ferrules (D4, Lemo)	Universal patchcord tip for 2.5 mm ferrules
						
Part number	<b>FIPT-400-U25M-R</b>	<b>FIPT-400-U25MA</b>	<b>FIPT-400-U25MA-R</b>	<b>FIPT-400-Evolv</b>	<b>FIPT-400-LC-D</b>	<b>FIPT-400-LC-D-APC</b>
Description	Ultra-rugged universal patchcord tip for 2.5 mm ferrule	Universal patchcord tip for 2.5 mm ferrules (APC)	Ultra-rugged universal patchcord tip for 2.5 mm/APC ferrule	Single-fiber port of the Corning Evolv™ terminal for the Pushlok connector	Duplex patchcord tip for LC-UPC connectors	Duplex patchcord tip for LC-APC connectors
						

## FIPT-400 adapters

Part number	<b>FIPT-400-ADAPTER*</b>	<b>FIPT-400-AD-A6</b>	<b>FIPT-400-AD-P5</b>
Description	<b>Adapter tip</b> Allows the user to attach any Westover probe tip that does not include optics to EXFO's probe	<b>60° adapter tip</b> Allows the user to obtain 60° angle capabilities on certain standard probe tips that do not include optics	<b>EXFO FIP tips to Westover FIP adapter</b> Allows the user to attach some EXFO FIP-400 probe tips to the old Westover probe.
			

## ODC 2 & 4 fibers tips and guides

Part number	<b>FIPT-400-ODC-U</b>	<b>FIPT-400-ODC-2PIN-P</b>	<b>FIPT-400-ODC-4PIN-P</b>	<b>FIPT-400-ODC-S</b>
Description	ODC universal guided tip (to be used with a plug guide)	ODC 2 pin plug (female) guide tip	ODC 4 pin plug (female) guide tip	ODC socket (male) tip
				

## Q-ODC® duplex tips and guides

Part number	<b>FIPT-400-QODC-2P</b>	<b>FIPT-400-QODC-2P-P</b>	<b>FIPT-400-QODC-2P-S</b>
Description	Q-ODC universal guided tip (to be used with a guide tip)	Q-ODC 2 pin plug (female) guide tip	Q-ODC 2 pin socket (male) guide tip
			

## Bulkhead FIPT-400 tips

<b>Part number</b>	<b>FIPT-400-D4</b>	<b>FIPT-400-E2000</b>	<b>FIPT-400-E2000-APC*</b>	<b>FIPT-400-E2000A-A6</b>	<b>FIPT-400-FC-APC</b>	<b>FIPT-400-FC-SC</b>
<b>Description</b>	D4 tip for bulkhead adapter	E-2000 tip for bulkhead adapter	E2000 APC tip for bulkhead adapter	E2000 APC angled tip for bulkhead adapter; 60° angle	FC/APC tip for bulkhead adapter	FC and SC tip for bulkhead adapter
						
<b>Part number</b>	<b>FIPT-400-FC-SC-A6</b>	<b>FIPT-400-LC-SQ</b>	<b>FIPT-400-LC-A6</b>	<b>FIPT-400-LC-L</b>	<b>FIPT-400-LC-L-137</b>	<b>FIPT-400-LC-APC</b>
<b>Description</b>	FC and SC angled tip for bulkhead adapter; 60° angle	LC tip for bulkhead adapter	LC angled tip for bulkhead adapter; 60° angle	58.5 mm, extended LC tip for PC bulkhead adapter	137 mm, extended LC tip for PC bulkhead adapter	LC/APC tip for bulkhead adapter
						
<b>Part number</b>	<b>FIPT-400-LC-APC-L</b>	<b>FIPT-400-LEMO</b>	<b>FIPT-400-LX.5</b>	<b>FIPT-400-LX5-APC*</b>	<b>FIPT-400-MDC-APC</b>	<b>FIPT-400-MIL-2CPA</b>
<b>Description</b>	61 mm, LC/APC extended tip for bulkhead connector	Lemo bulkhead adapter	LX.5/PC tip for bulkhead connector	LX.5/APC tip for bulkhead adapter	MDC tip for MDC/APC bulkhead connector	Tip to inspect Glenair D38999 plug
						
<b>Part number</b>	<b>FIPT-400-MTRJ*</b>	<b>FIPT-400-MU</b>	<b>FIPT-400-MU-L</b>	<b>FIPT-400-MU-L-149</b>	<b>FIPT-400-SC-APC</b>	<b>FIPT-400-SC-APC-L</b>
<b>Description</b>	MTRJ tip for MTRJ bulkhead	MU tip for bulkhead adapters	Extended MU tip for PC bulkhead adapter	149 mm, extended MU tip for PC bulkhead adapter	SC/APC tip for bulkhead adapter	54 mm, SC angled extended tip for bulkhead connector
						
<b>Part number</b>	<b>FIPT-400-SC-L</b>	<b>FIPT-400-SC-L-149</b>	<b>FIPT-400-SMA*</b>	<b>FIPT-400-SMAM*</b>	<b>FIPT-400-ST</b>	<b>FIPT-400-OTAP-APC</b>
<b>Description</b>	56.5 mm, extended SC tip for PC bulkhead adapter	149 mm, extended SC tip for PC bulkhead adapter	SMA tips for bulkhead connector	SMA tip for male connector	ST tip for bulkhead adapter	OptiTap™ bulkhead adapter
						
<b>Part number</b>	<b>FIPT-400-SN</b>	<b>FIPT-400-CS</b>	<b>FIPT-400-MDC-APC (NS2949)</b>			
<b>Description</b>	SN/UPC bulkhead connector (including SN bulkhead adapter for patchcord inspection)	CS/UPC for bulkhead connector (including CS bulkhead adapter for patchcord inspection)	MDC tip for NS2949 MDC/APC Bulkhead connector			
						





\* Pass/Fail analysis not supported.

## Automated multifiber tips, nozzles and adapters \*









<b>Part number</b>	<b>FIPT-400-MF-MPO</b>	<b>FIPT-400-MF-MPO-APC</b>	<b>FIPT-400-MF-MPO-K</b>	<b>FIPT-400-MF-MPO-X</b>	<b>FIPT-400-MF-MPOX-A</b>
<b>Description</b>	Automated tip for MPO/UPC connectors (12-fiber row), one-hand operation. Compatible with single- and dual-row connectors, up to 24 fibers.	Automated tip for MPO/APC connectors (12-fiber row), one-hand operation. Compatible with single- and dual-row connectors, up to 24 fibers.	Automated tip kit for MPO/UPC and MPO/APC connectors (12-fiber row), one-hand operation. Compatible with single- and dual-row connectors, up to 24 fibers.	Automated tip for MPO-16/UPC connectors (16-fiber row), one-hand operation. Compatible with single- and dual-row connectors, up to 32 fibers.	Automated tip for MPO-16/APC connectors (16-fiber row), one-hand operation. Compatible with single- and dual-row connectors, up to 32 fibers.
					
<b>Part number</b>	<b>FIPT-400-MF-MPOX-K</b>	<b>FIPT-400-NZ-MPO</b>	<b>FIPT-400-NZ-MPO-APC</b>	<b>FIPT-NZ-MPO-X</b>	<b>FIPT-NZ-MPO-X-APC</b>
	Automated tip kit for MPO/UPC and MPO/APC connectors (16-fiber row), one-hand operation. Compatible with single- and dual-row connectors, up to 32 fibers.	MPO/UPC replaceable nozzle for FIPT-400-MF automated tip for 12-fiber row connectors. Compatible with single- and dual-row connectors, up to 24 fibers.	MPO/APC replaceable nozzle for FIPT-400-MF automated tip for 12-fiber row connectors. Compatible with single- and dual-row connectors, up to 24 fibers.	MPO/UPC replaceable nozzle for FIPT-400-MF automated tip for 16-fiber row connectors. Compatible with single- and dual-row connectors, up to 32 fibers.	MPO/APC replaceable nozzle for FIPT-400-MF automated tip for 16-fiber row connectors. Compatible with single- and dual-row connectors, up to 32 fibers.
					
<b>Part number</b>	<b>FIPT-MPO-BLK</b>	<b>FIPT-MPO-X-BLK</b>	<b>FIPT-400-MF-QODC12</b>	<b>FIPT-400-MF-QODC12-APC</b>	<b>FIPT-400-NZ-QODC12</b>
	Specialized bulkhead adapter for patchcord inspection for 12-fiber row connectors. Compatible with single- and dual-row connectors, up to 24 fibers.	Specialized bulkhead adapter for patchcord inspection for 16-fiber row connectors. Compatible with single- and dual-row connectors, up to 32 fibers.	Automated tip for QODC-12/UPC connectors (12 fibers); one hand operation. Compatible with plug and socket connectors.	FIPT-400-MF automated tip for QODC-12/APC connectors (12 fibers); one hand operation. Compatible with plug and socket connectors.	QODC-12/UPC replaceable nozzle for FIPT-400-MF automated tip for 12-fiber row connectors. Include nozzles for plug and socket connectors.
					
<b>Part number</b>	<b>FIPT-400-NZ-QODC12-APC</b>	<b>FIPT-400-MF-OTIP-APC</b>	<b>FIPT-400-NZ-OTIP-APC</b>	<b>FIPT-400-MF-MT</b>	<b>FIPT-400-MF-MT-APC</b>
	QODC-12/APC replaceable nozzle for FIPT-400-MF automated tip for 12-fiber row connectors. Include nozzles for plug and socket connectors.	Automated tip for Optitip-MT®/APC and HMFOC®/APC connectors (12-24 fibers), one hand operation. Compatible with single and dual-row connectors, up to 24 fibers. Compatible with male and female connectors.	Optitip MT/APC and HMFOC®/APC replaceable nozzle for FIPT-400-MF automated tip, includes two nozzles for male and female connectors.	Automated multifiber tip for MT/UPC patchcord connectors (12&16-fiber row), one-hand operation. Compatible with single- and dual-row connectors.	Automated multifiber tip for MT/APC patchcord connectors (12&16-fiber row), one-hand operation. Compatible with single- and dual-row connectors.
					
<b>Part number</b>	<b>FIPT-400-MF-MT-K</b>	<b>FIPT-400-NZ-MT</b>	<b>FIPT-400-NZ-MT-APC</b>		
	Automated multifiber tip for MT/UPC and MT/APC patchcord connectors (12&16-fiber row), one-hand operation. Compatible with single- and dual-row connectors.	MT/UPC replaceable nozzle for FIPT-400-MF automated tip for MT/UPC patchcord connectors (12&16-fiber row). Compatible with single and dual-row connectors.	MT/APC replaceable nozzle for FIPT-400-MF automated tip for MT/APC patchcord connectors (12&16-fiber row). Compatible with single and dual-row connectors.		
					

\* Requires the FIP-400B MF-Ready version



## Manual MPO tips (with scanning knobs), nozzle and adapters

<b>Part number</b>	<b>FIPT-400-MTP-MTR *</b>	<b>FIPT-400-MTP-MTRA</b>	<b>FIPT-400-MTP-MTR-K</b>	<b>FIPT-400-MTPA-TIP</b>	<b>FIPT-400-MTP2-TIP</b>
<b>Description</b>	MTP/MPO/UPC multirow tip for bulkhead adapter	MTP/MPO multirow APC tip for bulkhead adapter: includes a bulkhead adapter for patchcord inspection	MTP-MPO/APC and UPC multirow tip for bulkhead adapter	MTP-MPO/APC replaceable nozzle for single or multirow adapter	MTP/MPO multirow APC tip for bulkhead adapter: includes a bulkhead adapter for patchcord inspection
					
<b>Part number</b>	<b>FIPT-400-MTP-BLK</b>				
<b>Description</b>	Bulkhead adapter for MPO patchcord inspection				
					

## Tip adapter kits

<b>Part number</b>	<b>FIPT-400-LC-K</b>		<b>FIPT-400-LC-K-APC</b>	<b>FIPT-400-LC-K-UPC</b>	<b>FIPT-400-SCA-K</b>	<b>FIPT-400-ODC4-PINP-K</b>
<b>Description</b>	LC tip kit including: › FIPT-400-LC: LC tip for bulkhead adapters › FIPT-400-LC-APC: LC/APC tip for bulkhead adapter › FIPT-400-U12M: universal patchcord tip for 1.25 mm ferrules › FIPT-400-U12MA: universal patchcord tip for 1.25 mm ferrules (APC)		LC tip kit including: › FIPT-400-LC-APC: LC/APC tip for bulkhead adapter › FIPT-400-U12MA: Universal patchcord tip for 1.25 mm ferrules (APC)	LC tip kit including: › FIPT-400-LC: LC tip for bulkhead adapters › FIPT-400-U12M: universal patchcord tip for 1.25 mm ferrules	2.5 mm APC tip kit including: › FIPT-400-U25MA › FIPT-400-SC-APC	ODC 4 pin plug (female) guide and universal tip Kit includes: › FIPT-400-ODC-U › FIPT-400-ODC-4PIN-P › FIPT-400-ODC-4PIN-P
						
<b>Part number</b>	<b>FIPT-400-ODC2-4PINP-K</b>	<b>FIPT-400-ODC2-PINP-K</b>	<b>FIPT-400-QODC-2P-K</b>			
<b>Description</b>	ODC 2 and 4 pin plug (female) guides and universal tip Kit includes: › FIPT-400-ODC-U › FIPT-400-ODC-2PIN-P › FIPT-400-ODC-4PIN-P	ODC 2 pin plug (female) guide and universal tip Kit includes: › FIPT-400-ODC-U › FIPT-400-ODC-2PIN-P	QODC 2 pin plug (female) and socket (male) guide and universal guided tip Kit includes: › FIPT-400-QODC-2P › FIPT-400-QODC-2P-P › FIPT-400-QODC-2P-S			
						

## Accessories for FIPTs

<b>Part number</b>	<b>GP-3108</b>	<b>FIPT-BOX</b>	<b>FIPT-BOX-MF</b>
<b>Description</b>	Compartmented soft pouch › (1) one FIP-400B inspection probe › Tips and accessories	Compartmented plastic case for tips › short reach tips (e.g., FIPT-400-U20M) and long reach tips (e.g., FIPT-400-LC-L)	Compartmented plastic case for tips MF › FIPT-400-MF-XX automated multi-fiber tip
			

\* Pass/Fail analysis not supported on ConnectorMax Mobile for smart devices

## Is my FIP-400 probe MF-Ready?

EXFO's multi-fiber solution is compatible with FIP-400B MF-Ready versions. To verify whether it is MF-Ready, check your FIP-400B for the black retaining nut and the MF-Ready engraving.

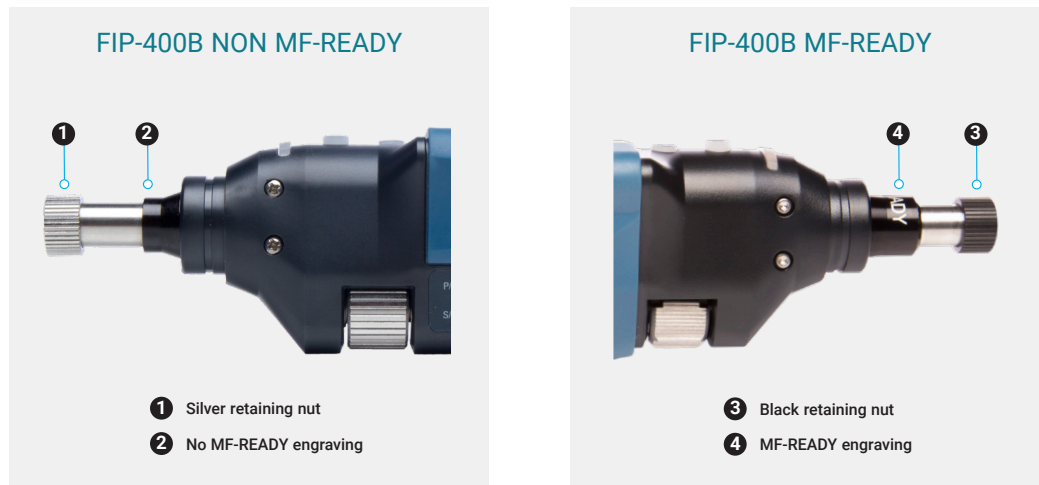

If your FIP-400B is not MF-Ready, contact EXFO at [isales@exfo.com](mailto:isales@exfo.com) for an upgrade.

MTP® is a registered trademark of US Conec Ltd.  
Evolv™, OptiSheath®, OptiTap® and OptiTip® are trademarks of Corning Optical Communications  
ODC® and Q-ODC® are registered trademarks of HUBER+SUHNER



[WWW.SPECIALIZED.NET](http://WWW.SPECIALIZED.NET)

Debbi Kosakowski - National Sales Manager · [dkosakowski@specialized.net](mailto:dkosakowski@specialized.net) · 727-515-0911  
Eleanor Barszowski - NE Regional Sales Manager · [ebarzowski@specialized.net](mailto:ebarszowski@specialized.net) · 484-955-3178  
Carolyn Thompson - CSR Midwest/NE · [carolyn@specialized.net](mailto:carolyn@specialized.net) · 813-295-9889  
Becca Bowman - CSR NE/Western · [bbowman@specialized.net](mailto:bbowman@specialized.net) · 727-412-1591